

Features

- Diffused Junction
- Low Forward Voltage Drop
- High Surge Current Capability
- High Reliability
- Ideally Suited for Use in High Frequency SMPS, Inverters and As Free Wheeling Diodes

Mechanical Data

- Case: DO-15, Molded Plastic
- Terminals: Plated Leads Solderable per MIL-STD-202, Method 208
- Polarity: Cathode Band
- Weight: 0.40 grams (approx.)
- Mounting Position: Any
- Marking: Type Number
- **Lead Free: For RoHS / Lead Free Version**

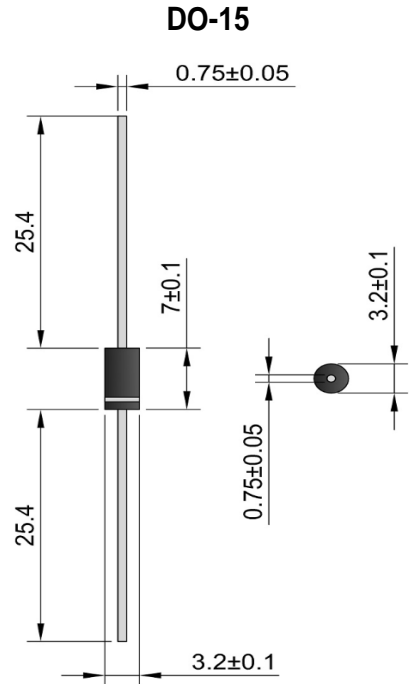

Maximum Ratings and Electrical Characteristics @T_A=25°C unless otherwise specified

Single Phase, half wave, 60Hz, resistive or inductive load.
For capacitive load, derate current by 20%.

Characteristic	Symbol	HER 201	HER 202	HER 203	HER 204	HER 205	HER 206	HER 207	HER 208	Unit
Peak Repetitive Reverse Voltage	V _{RRM}	50	100	200	300	400	600	800	1000	V
Working Peak Reverse Voltage	V _{RWM}									
DC Blocking Voltage	V _R									
RMS Reverse Voltage	V _{R(RMS)}	35	70	140	210	280	420	560	700	V
Average Rectified Output Current (Note 1) @T _A = 50°C	I _O	2.0								A
Non-Repetitive Peak Forward Surge Current 8.3ms Single Half Sine-Wave Superimposed on Rated Load (JEDEC Method)	I _{FSM}	60								A
Forward Voltage @I _F = 2.0A	V _{FM}	1.0			1.3		1.7			V
Peak Reverse Current @T _A = 25°C At Rated DC Blocking Voltage @T _A = 100°C	I _{RM}	5.0				100				μA
Reverse Recovery Time (Note 2)	t _{rr}	50				75				nS
Typical Junction Capacitance (Note 3)	C _J	50				30				pF
Typical Thermal Resistance Junction to Ambient (Note 1)	R _{JA}	40								°C/W
Typical Thermal Resistance Junction to Lead (Note 1)	R _{JL}	15								
Operating Temperature Range	T _J	-65 to +125								°C
Storage Temperature Range	T _{STG}	-65 to +150								°C

Note: 1. Leads maintained at ambient temperature at a distance of 9.5mm from the case.
2. Measured with I_F = 0.5A, I_R = 1.0A, I_{RR} = 0.25A.
3. Measured at 1.0 MHz and Applied Reverse Voltage of 4.0V D.C.

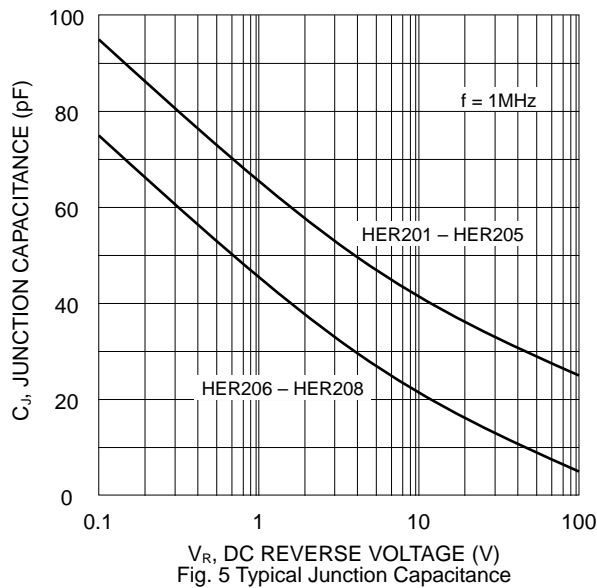
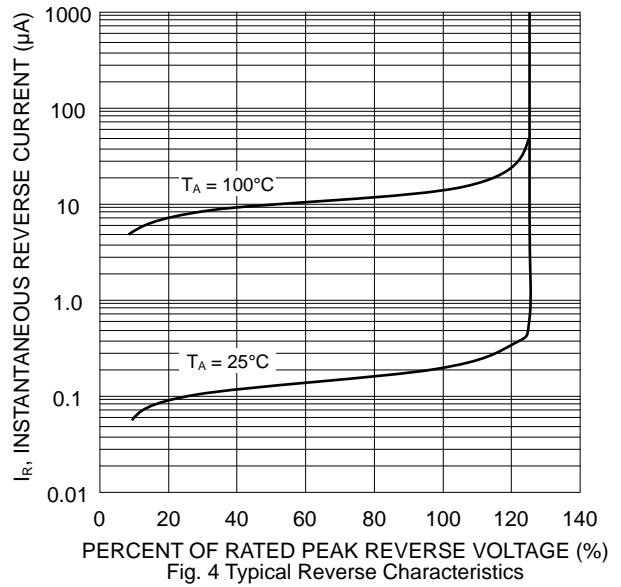
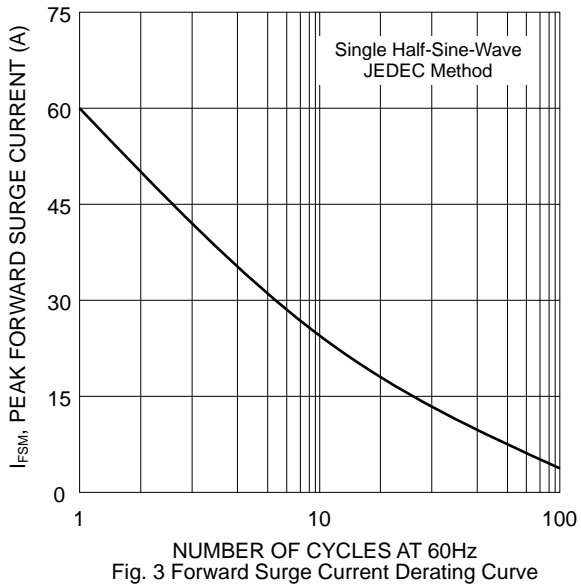
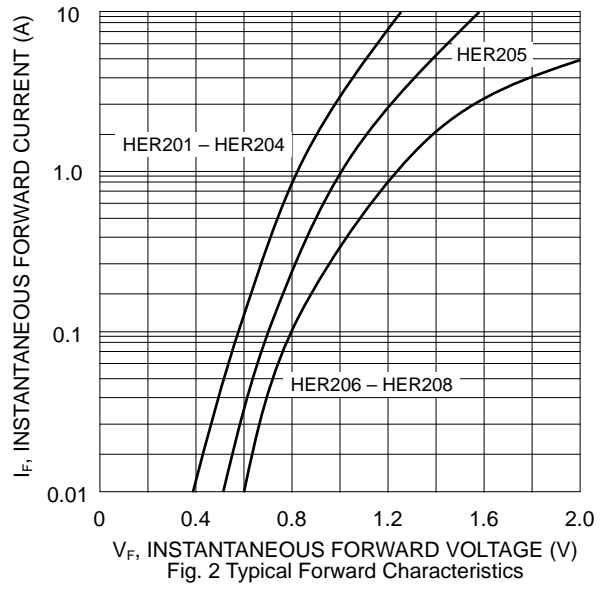
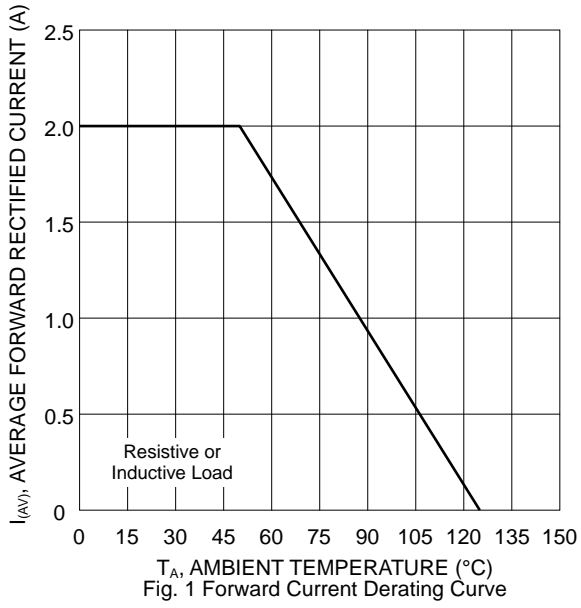

MARKING INFORMATION

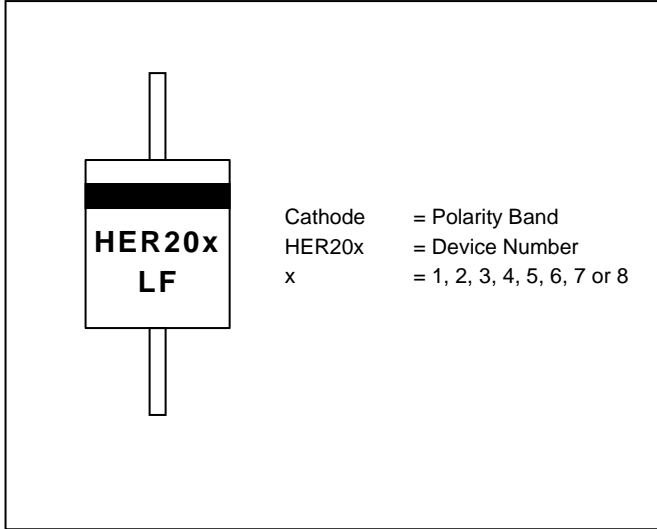

TAPING SPECIFICATIONS

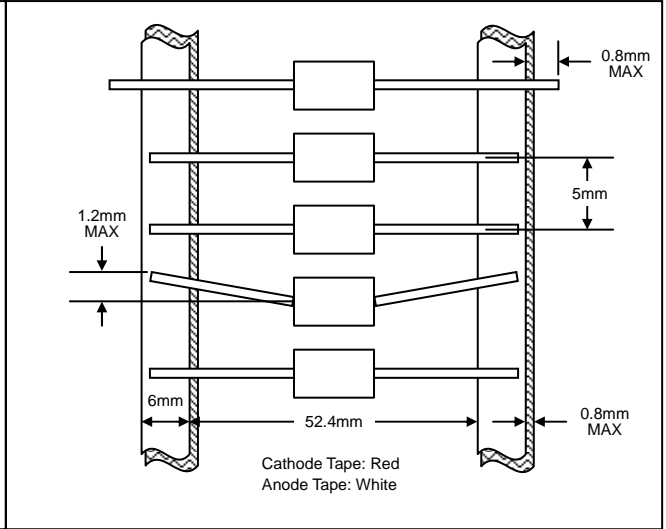

PACKAGING INFORMATION

TAPE & REEL

330mm
 Product ID Label
 80±5mm

TAPE & BOX

150mm
 255mm
 75mm
 Product ID Label
 Inspection Hole (both ends)

BULK

25mm
 200mm
 85mm

Packaging	Reel Diameter / Box Size (mm)	Quantity (PCS)	Carton Size (mm)	Quantity (PCS)	Approx. Gross Weight (KG)
TAPE & REEL	330	4,000	370 x 370 x 420	20,000	12.0
TAPE & BOX	255 x 75 x 150	3,000	400 x 273 x 415	30,000	15.0
BULK	200 x 85 x 25	1,000	459 x 214 x 256	40,000	17.5