

Features

- Fred Chip Planar Construction
- Ultrafast 50nS and 100nS Recovery Time
- Low Forward Voltage Drop
- Low Reverse Leakage Current
- High Surge Current Capability
- Epoxy Meets UL 94V-0 Classification
- Ideally Suited for Use in High Frequency SMPS, Inverters and As Free Wheeling Diodes

Mechanical Data

- Case: TO-220A, Molded Plastic
- Terminals: Plated Leads Solderable per MIL-STD-202, Method 208
- Polarity: See Diagram
- Weight: 1.9 grams (approx.)
- Mounting Position: Any
- Mounting Torque: 0.6 N.m Max.
- **Lead Free: For RoHS / Lead Free Version**

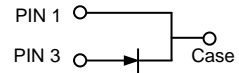
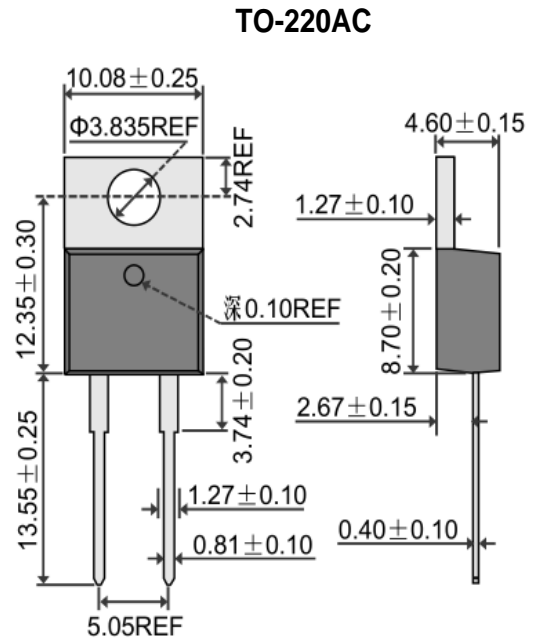

Maximum Ratings and Electrical Characteristics @T_A=25°C unless otherwise specified

Single Phase, half wave, 60Hz, resistive or inductive load. For capacitive load, derate current by 20%.

Characteristic	Symbol	UF800	UF801	UF802	UF803	UF804	UF806	UF808	Unit
Peak Repetitive Reverse Voltage	V _{RRM}								
Working Peak Reverse Voltage	V _{RWM}	50	100	200	300	400	600	800	V
DC Blocking Voltage	V _R								
RMS Reverse Voltage	V _{R(RMS)}	35	70	140	210	280	420	560	V
Average Rectified Output Current @T _C = 100°C	I _O	8.0							A
Non-Repetitive Peak Forward Surge Current 8.3ms Single Half Sine-Wave Superimposed on Rated Load (JEDEC Method)	I _{FSM}	125							A
Forward Voltage @I _F = 8.0A	V _{FM}	1.0		1.3		1.7	1.8	V	
Peak Reverse Current @T _A = 25°C	I _{RM}	10							μA
At Rated DC Blocking Voltage @T _A = 125°C		500							
Reverse Recovery Time (Note 1)	t _{rr}	50					100		nS
Typical Junction Capacitance (Note 2)	C _J	80					50		pF
Thermal Resistance Junction to Ambient	R _{JA}	73							°C/W
Thermal Resistance Junction to Case	R _{JC}	3.0							
Operating and Storage Temperature Range	T _J , T _{STG}	-55 to +150							°C

Note: 1. Measured with I_F = 0.5A, I_R = 1.0A, I_{RR} = 0.25A.
2. Measured at 1.0 MHz and applied reverse voltage of 4.0V D.C.

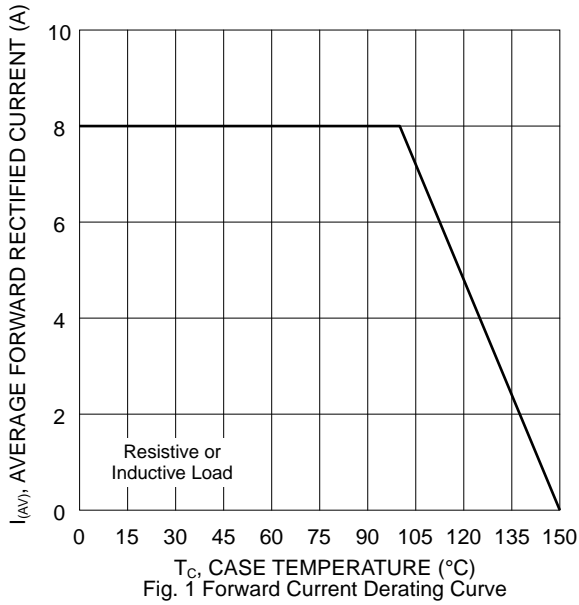

Fig. 1 Forward Current Derating Curve

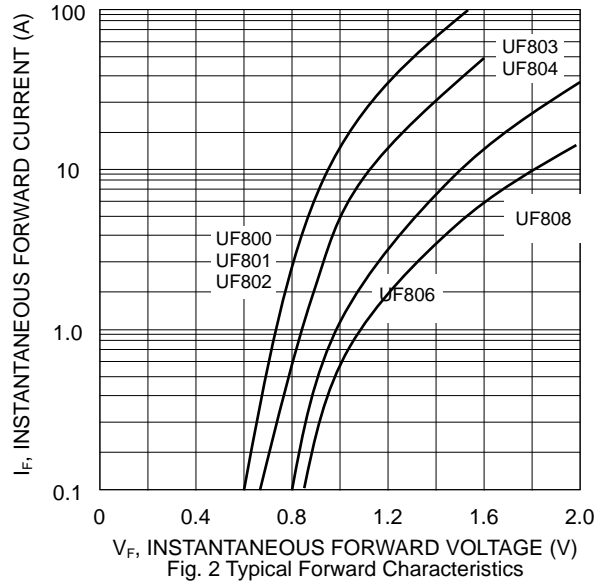

Fig. 2 Typical Forward Characteristics

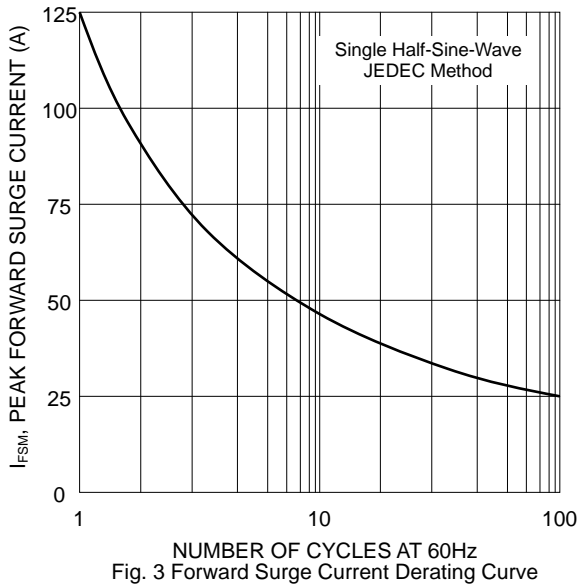

Fig. 3 Forward Surge Current Derating Curve

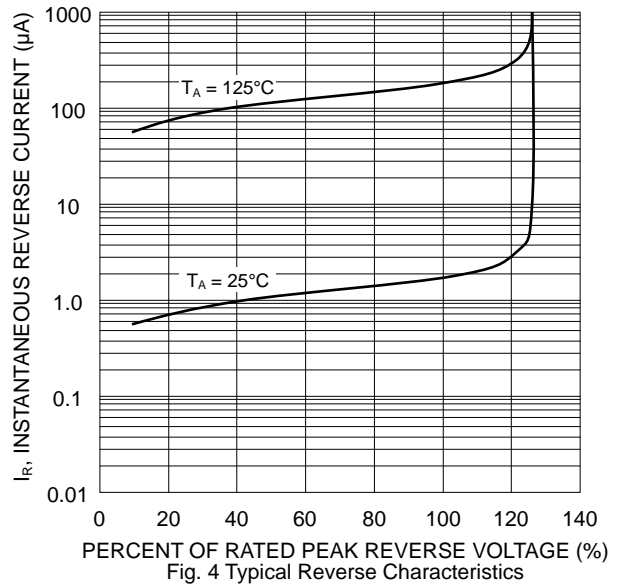

Fig. 4 Typical Reverse Characteristics

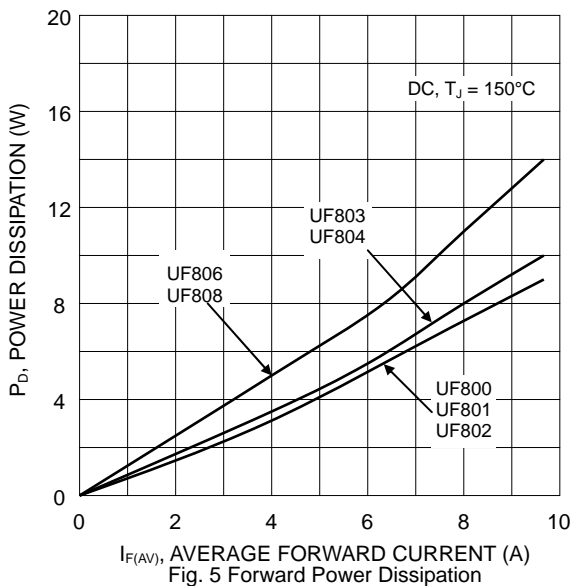

Fig. 5 Forward Power Dissipation

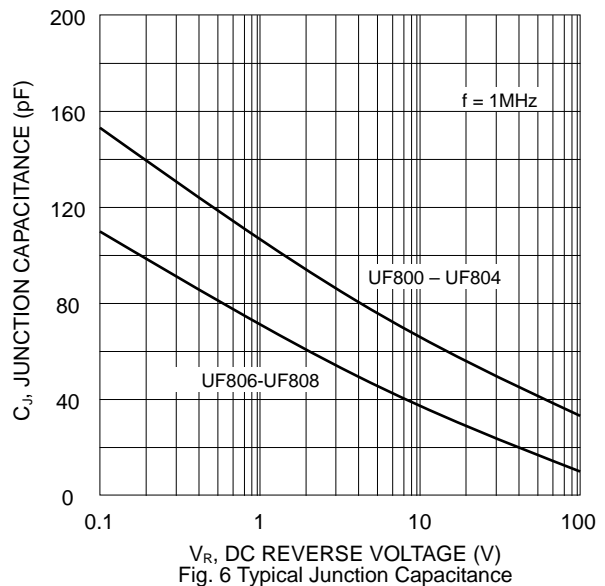
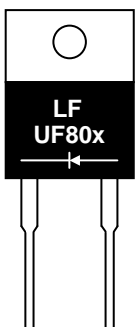

Fig. 6 Typical Junction Capacitance

MARKING INFORMATION



UF80x = Device Number
 x = 0, 1, 2, 3, 4, 6 or 8
 Polarity = As Marked on Body

PACKAGING INFORMATION

BULK

Tube Size L x W x H (mm)	Quantity (PCS)	Inner Box Size L x W x H (mm)	Quantity (PCS)	Carton Size L x W x H (mm)	Quantity (PCS)	Approx. Gross Weight (KG)
525 x 31 x 6	50	558 x 150 x 40	1,000	570 x 235 x 170	5,000	11.85

RECOMMENDED SCREW MOUNTING ARRANGEMENT

Recommended isolated mounting when screw is at heatsink potential. 4-40 hardware is used.

Screw should not be tightened with any type of air-forced torque or equipment that may cause high impact on device package. The insulating bushing inside the mounting hole will insure the screw threads do not contact the metal base.

The interface should apply a layer of thermal grease or a highly conductive thermal pad for better heat dissipation.

